

ViewSonic®

N2600w
LCD TV

- User Guide
- Guide de l'utilisateur
- Bedienungsanleitung
- Guía del usuario
- Guida dell'utente
- Användarhandbok
- Käyttöopas
- Руководство пользователя
- المستخدم دليل



Model No.: VS10946-1E

Contents

Compliance Information.....	1
Important Safety Instructions.....	2
Copyright Information	3
Product Registration	3
Antenna Installation Instructions.....	4
Cleaning the LCD TV.....	4

Getting Started

Package Contents	5
The wall type is installed.....	6
Move loudspeaker secure.....	7
Side View of the Product	8
Rear View of the Product.....	9
Remote Control	11
Installation	13
Basic Operation	22

OSD Functions

OSD style and operation tips.....	23
OSD Operation.....	23

Other Information

Specifications	32
Troubleshooting.....	33
Customer Support	35
Limited Warranty	36

Compliance Information

CE Conformity for European Countries

CE Conformity



The device complies with the requirements of the EEC directive 89/336/EEC as amended by 92/31/EEC and 93/68/EEC Art.5 with regard to “Electromagnetic compatibility” , and 73/23/EEC as amended by 93/68/EEC Art.13 with regard to “Safety.”

User Information for all Countries

Notice: Use the cables which are included with the unit or specified.

Important Safety Instructions

1. Read these instructions completely before using the equipment.
2. Keep these instructions in a safe place.
3. Heed all warnings.
4. Follow all instructions.
5. Do not use this equipment near water.
6. Clean with a soft, dry cloth. If further cleaning is required, see “Cleaning the LCD TV” in this guide for further instructions.
7. Do not block any ventilation openings. Install the equipment in accordance with the manufacturer’s instructions.
8. Do not install near any heat sources such as radiators, heat registers, stoves, or other devices (including amplifiers) that produce heat.
9. Do not attempt to circumvent the safety provisions of the polarized or grounding-type plug. A polarized plug has two blades with one wider than the other. A grounding type plug has two blades and a third grounding prong. The wide blade and the third prong are provided for your safety. If the plug does not fit into your outlet, consult an electrician for replacement of the outlet.
10. Protect the power cord from being tread upon or pinched, particularly at the plug, and the point where it emerges from the equipment. Be sure that the power outlet is located near the equipment so that it is easily accessible.
11. Only use attachments/accessories specified by the manufacturer.
12. Use only with the cart, stand, tripod, bracket, or table specified by the manufacturer, or sold with the equipment. When a cart is used, use caution when moving the cart/equipment combination to avoid injury from tipping over.
13. Unplug this equipment when it will be unused for long periods of time.
14. Refer all servicing to qualified service personnel. Service is required when the unit has been damaged in any way, such as: if the power-supply cord or plug is damaged, if liquid is spilled onto or objects fall into the unit, if the unit is exposed to rain or moisture, or if the unit does not operate normally or has been dropped.



Copyright Information

Copyright © ViewSonic® Corporation, 2006. All rights reserved.

ViewSonic, the three birds logo, OnView, ViewMatch, and ViewMeter are registered trademarks of ViewSonic Corporation.

Disclaimer: ViewSonic Corporation shall not be liable for technical or editorial errors or omissions contained herein; nor for incidental or consequential damages resulting from furnishing this material, or the performance or use of this product.

In the interest of continuing product improvement, ViewSonic Corporation reserves the right to change product specifications without notice. Information in this document may change without notice.

No part of this document may be copied, reproduced, or transmitted by any means, for any purpose without prior written permission from ViewSonic Corporation.

Product Registration

To meet your future needs, and to receive any additional product information as it becomes available, please register your product on the Internet at: www.viewsonic.com.

For Your Records

Product Name:	N2600w ViewSonic LCD TV
Model Number:	VS10946-1E
Document Number:	N2600w-1E_UG_ENG Rev. 1A 12-15-05
Serial Number:	_____
Purchase Date:	_____

Product disposal at end of product life

ViewSonic is concerned about the preservation of our environment. Please dispose of this product properly at the end of its useful life. Your local waste disposal company may provide information about proper disposal.

The lamp in this product contains mercury. Please dispose of properly in accordance with environmental laws of your location.

Antenna Installation Instructions

1. Outdoor Antenna Grounding

If an outside antenna or cable system is connected to the product be sure the antenna or cable system is grounded so as to provide some protection against voltage surges and built-up static charges, Article 810 of the National Electrical Code, ANSI/NFPA 70, provides information with regard to proper grounding of the mast and supporting structure, grounding of the lead-in wire to an antenna discharge unit, connection to grounding electrodes, and requirements for the grounding electrode.

2. Lightning

For added protection for this product during a lightning storm, or when it is left unattended and unused for long periods of time, unplug it from the wall outlet and disconnect the antenna or cable system. This will prevent damage to the product due to lightning and power-line surges. Do not disconnect the antenna or the power cord during a heavy storm lightning may strike while you are holding the cable cord, causing serious injury; turn off your LCD TV and wait for the weather to improve.

3. Power Lines

An outside antenna system should not be located in the vicinity of overhead power lines or other electric light or power circuits, or where it can fall into such power lines or circuits, When installing an outside antenna system, extreme care should be taken to keep from touching such power lines or circuits as contact with them might be fatal.



Cleaning the LCD TV

- Make sure the LCD TV is turned off.
- Never spray or pour any liquid directly onto the screen or case.

To clean the screen:

- 1 Wipe the screen with a clean, soft, lint-free cloth. This removes dust and other particles.
- 2 If still not clean, apply a small amount of non-ammonia, non-alcohol based glass cleaner onto a clean, soft, lint-free cloth, and wipe the screen.

To clean the case:

- 1 Use a soft, dry cloth.
- 2 If still not clean, apply a small amount of a non-ammonia, non-alcohol based, mild non-abrasive detergent onto a clean, soft, lint-free cloth, then wipe the surface.

Disclaimer

ViewSonic® does not recommend the use of any ammonia or alcohol-based cleaners on the LCD TV screen or case. Some chemical cleaners have been reported to damage the screen and/or case of the LCD TV.

ViewSonic will not be liable for damage resulting from use of any ammonia or alcohol-based cleaners.

Getting Started

Congratulations on your purchase of a ViewSonic® LCD TV.

***Important!** Save the original box and all packing material for future shipping needs.*

Package Contents

Your LCD TV package includes:

- LCD TV
- Power Cable
- RF Cable
- Universal Remote Control with batteries
- ViewSonic User Guide
- Quick Start Guide

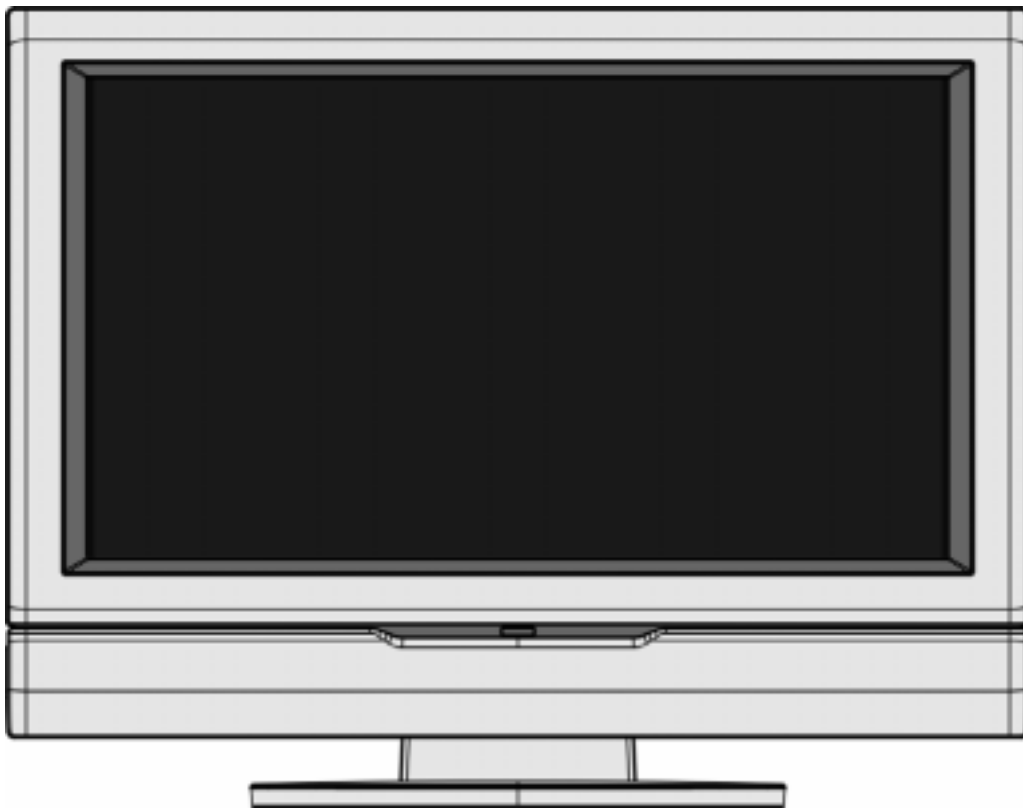

Setting the LCD TV on the wall

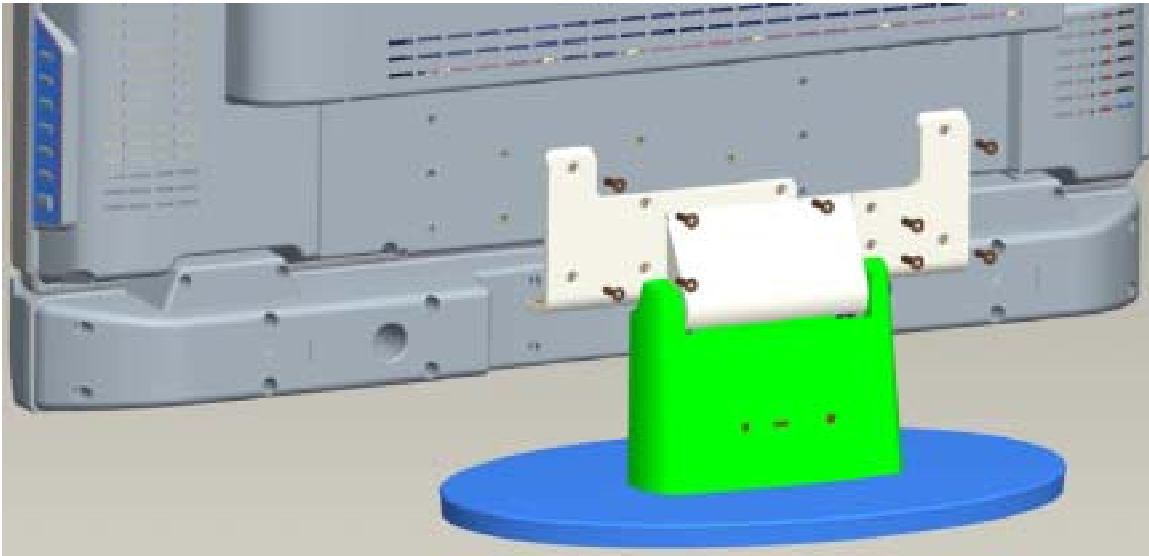

Hanging the LCD TV on the wall requires special skill that only be performed by qualified service personnel. Please contact ViewSonic or your local distributor for the installation instruction.

Hanging the LCD TV on the wall requires special skill that only be performed by qualified service personnel. Please contact ViewSonic or your local distributor for the installation instruction and service. Before hanging your LCD TV on the wall, please follow the steps below:

1. Turn off the AC switch on the back of your LCD TV.
2. Spread cushion over the base area to lay the LCD screen on.
3. Unfasten 9 screws in the base to detach the stand from the LCD screen.
4. Contact qualified service personnel for the optional VESA wall mount bracket.
5. Follow the instructions of the VESA wall mount bracket to mount the LCD TV to the wall.

Move loudspeaker secure

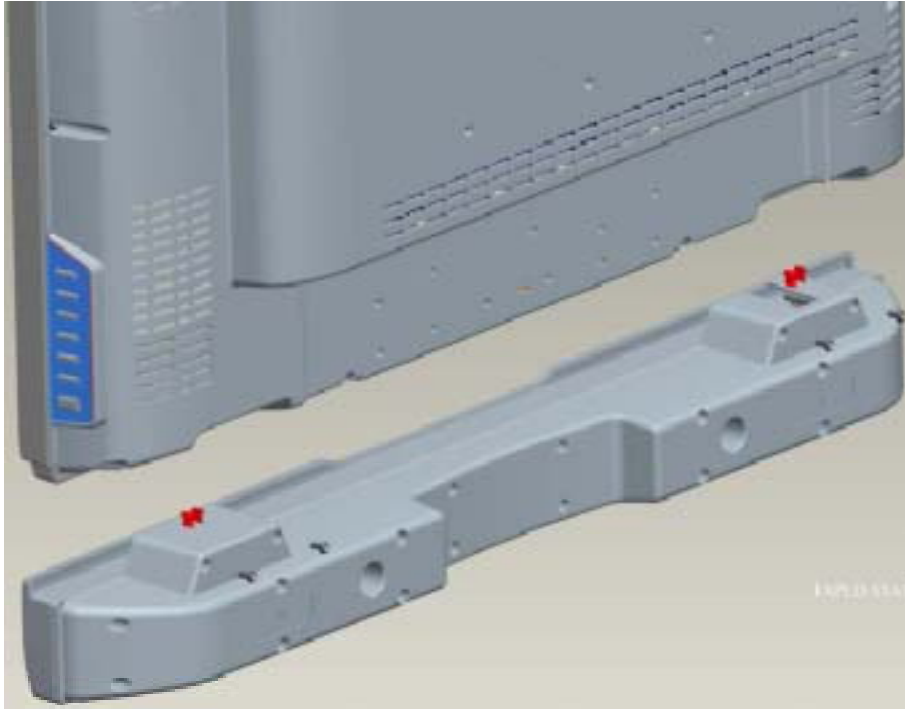

It please arrange with ViewSonic or your local distributor to move it except the loudspeaker. Please carry out and operate following:

1. Cut off the power to join.
2. Face LCD TV below on the towel or the woolen blanket.
3. Disassemble 9 screws in the base.
4. Move except that the base.
5. Disassemble 4 screws of the back loudspeaker.
6. Exert oneself downward, remove the loudspeaker.

Side View of the Product

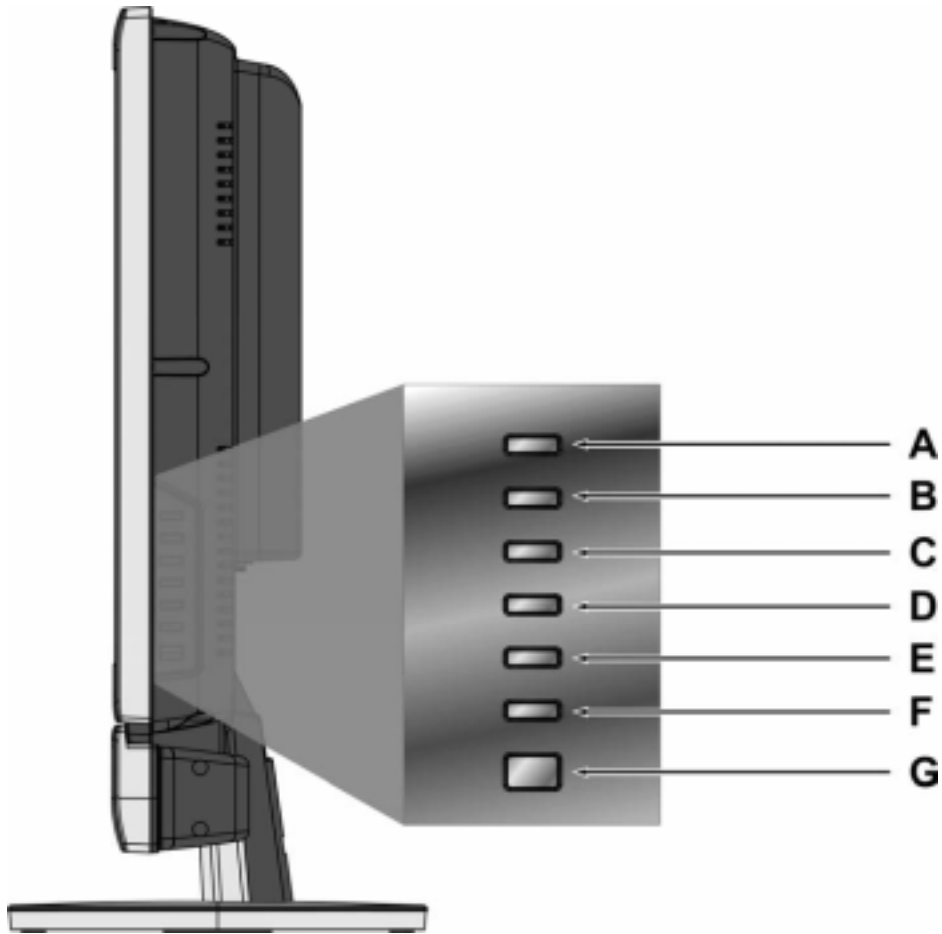

A	Input Select the Input source. Confirm OSD menu selection.
B	Volume Up Increase volume or adjust a highlighted increasingly control while in OSD menu.
C	Volume Down Decrease volume or adjust a highlighted control decreasingly while in OSD menu.
D	CH Up Channel up/ Scroll up.
E	CH Down Channel down/ Scroll down.
F	MENU Turn OSD menu ON/OFF.
G	Power Turn the power ON/OFF.

Rear View of the Product

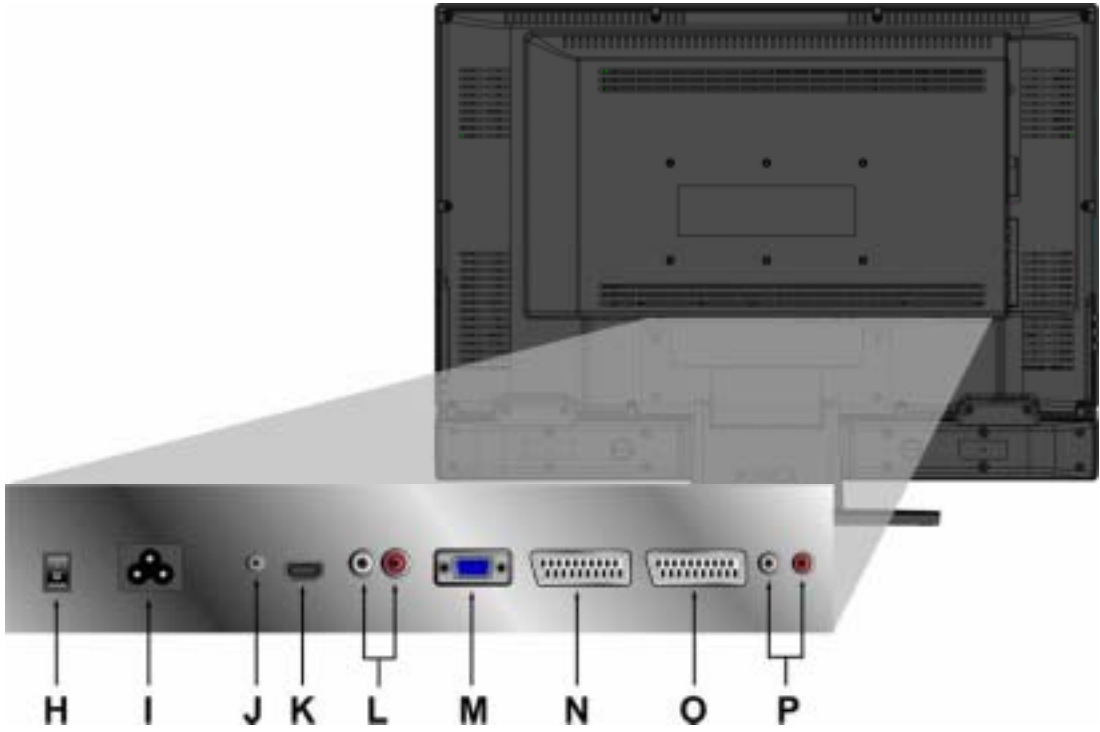
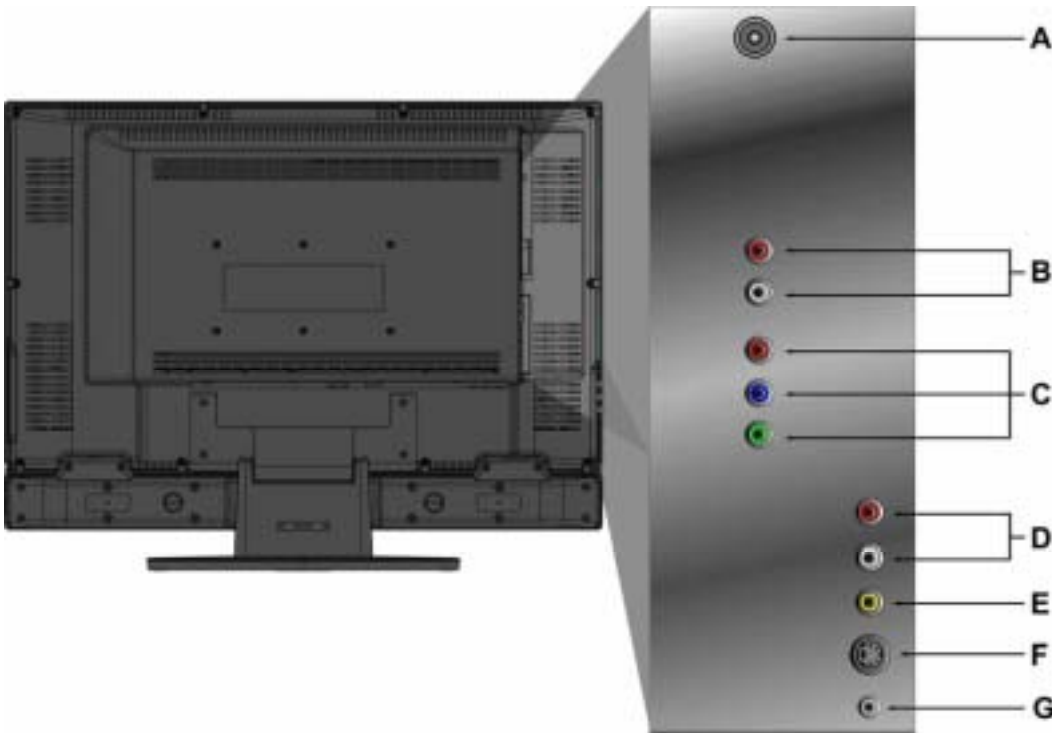

A	TV signal input Connect to the antenna or cable service.
B	YCbCr signal Audio input (left/right) Connect the external audio into this jack.
C	YCbCr signal input Connect the external video device with component output to these jacks.
D	AV/ S-Video signal Audio input (left/right) Connect the external audio into this jack.
E	AV Video input Connect the external video devices such as VCR, DVD and video game into this jack.
F	S-Video input Connect the external video device such as VCR, DVD and video game into this jack.
G	Earphone output
H	AC power switch (Default = ON)
I	Power (AC input) Using cable provided, connect to a power source.
J	PC Audio input
K	HDMI signal input
L	HDMI-DVI Audio input Connect the external video devices with RCA audio output to these jacks.
M	VGA signal input
N	SCART2 Connect the scart socket of the VCR to the SCART2 socket on the LCD TV
O	SCART1 Connect the scart socket of the VCR to the SCART1 socket on the LCD TV
P	Audio output Connect this port to your external speaker

Remote Control

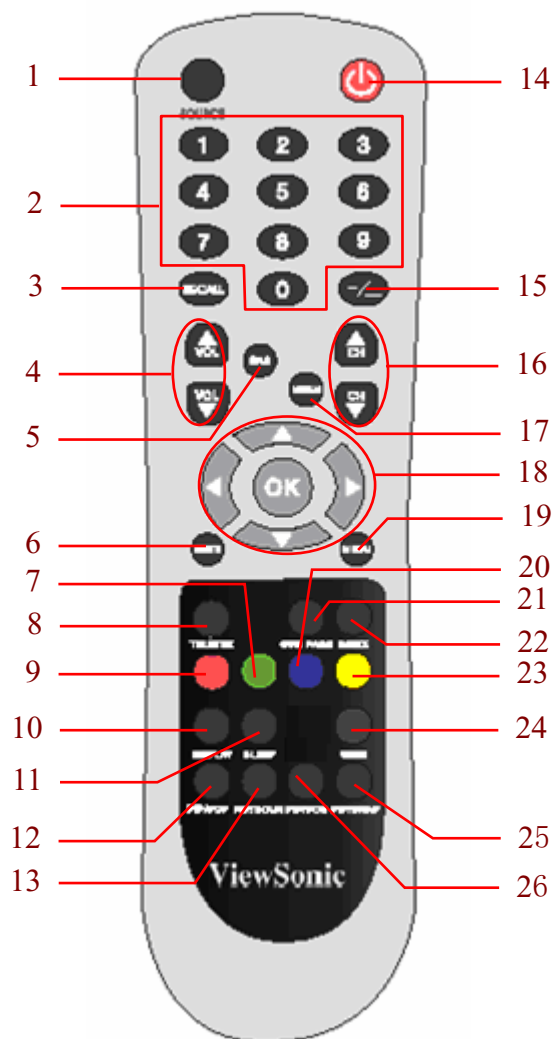

Remote control button function as follow

1	SOURCE	Select Input Source.
2	0~9	Input channel number.
3	Recall	Return to the previous channel.
4	Volume▲ / Volume▼	Adjust Volume.
5	SRS	Enable/Disable Surround Sound.
6	MUTE	Mute On/Off.
7	TELETEXT Function Key (Green)	Select the teletext pages color coded in green along the bottom of the screen.
8	TELETEXT	Switch Teletext On/Off.
9	TELETEXT Function Key (Red)	Select the teletext pages color coded in red along the bottom of the screen.
10	DISPLAY	Displays the sources and time.

11	SLEEP	Set timer to turn off TV.
12	PIP/POP	Activate PIP or POP feature.
13	PIP/SOUR	Press to toggle the Sub picture between PIP and POP.
14	POWER	Power ON/OFF.
15	-/—	Use this button to select the channel number with “-/—”.
16	Channel ▲ / Channel ▼	Change TV channels.
17	NICAM	Select the sound mode.
18	▲/▼/◀/▶/OK Button	▲/▼ for OSD function select and ◀/▶ for function adjust. VOL▲ and VOL▼ button can adjust the volume when there is no OSD menu display. CH▲ and CH▼ can change the channel on TV mode when there is no OSD menu display (For certain models).
19	Menu	Display menu, hold for 2~3 seconds to exit OSD menu.
20	TELETEXT Function Key (Blue)	Select the teletext pages color coded in blue along the bottom of the screen.
21	SUB PAGE	Select a secondary Teletext page.
22	INDEX	Select Teletext index page.
23	TELETEXT Function Key (Yellow)	Select the teletext pages color coded in yellow along the bottom of the screen.
24	WIDE	Change Aspect Ratio.
25	PIP/SWAP	Toggles between input sources for the Main and Sub picture.
26	PIP/POS	Change the display position of the Sub Picture in PIP mode.

Installation

1. Insert Remote Control Batteries

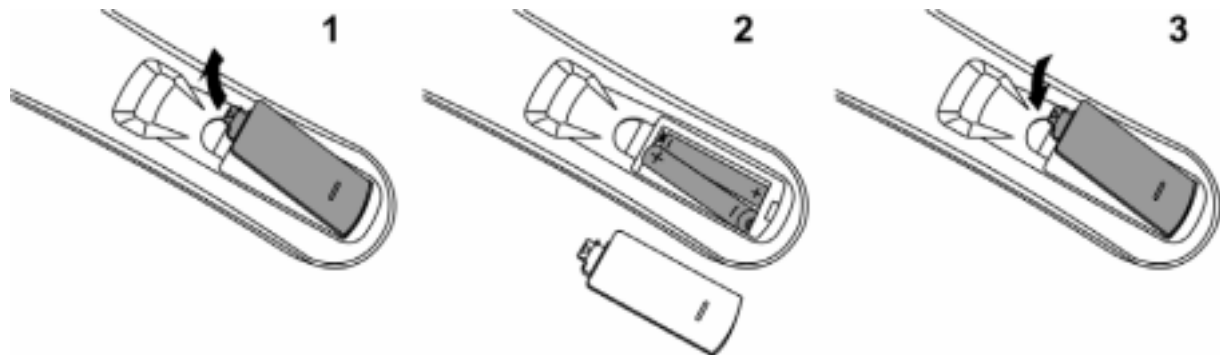

- 1 Remove the battery cover by pulling then lifting the knob on the cover.
- 2 Insert the batteries, corresponding to the (+) and (-) markings on the battery compartment.
- 3 Reattach the battery cover.



CAUTION

- Only use the specified AAA batteries.
- Do not mix new and old batteries. This may result in cracking or leakage, which may pose a risk of fire or lead to personal injury.
- Insert batteries according to (+) and (-) markings. Inserting the batteries incorrectly may result in cracking or leakage, which may pose a risk of fire or lead to personal injury.
- Dispose of the battery in accordance with local laws and regulations.
- Keep the battery away from children and pets.
- When the remote control will not to be used for an extended period, remove the batteries.

2. Connecting with the antenna

Make sure the power is off before installing N2600w.

Connect the LCD TV to TV antenna terminal or CATV box by 75-ohm coaxial cable.

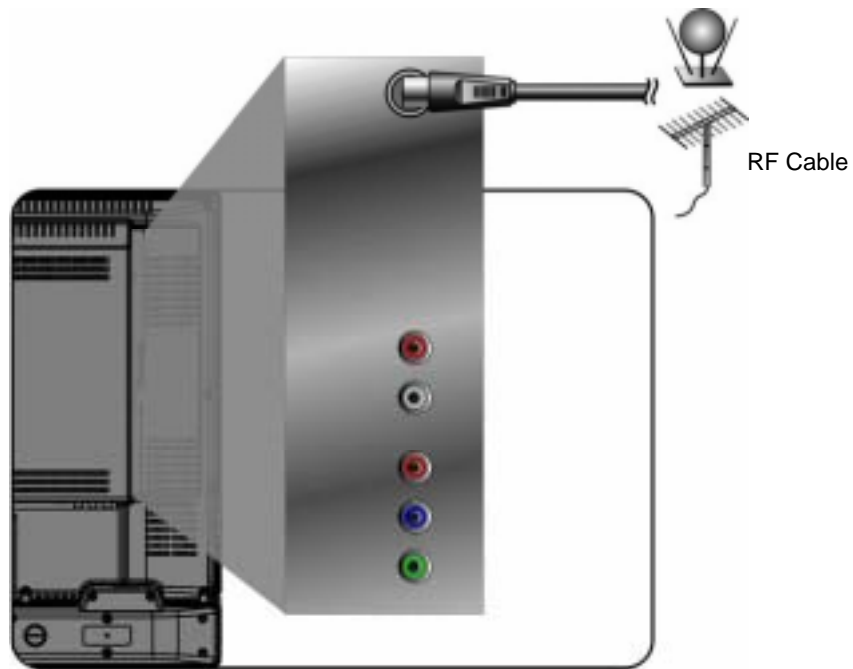

3. Connect Audio Cable

To connect an external amplifier, connect the L/R RCA cable from the TV AUDIO OUT port to the appropriate AUDIO IN port on a compatible amplifier as shown on the right.

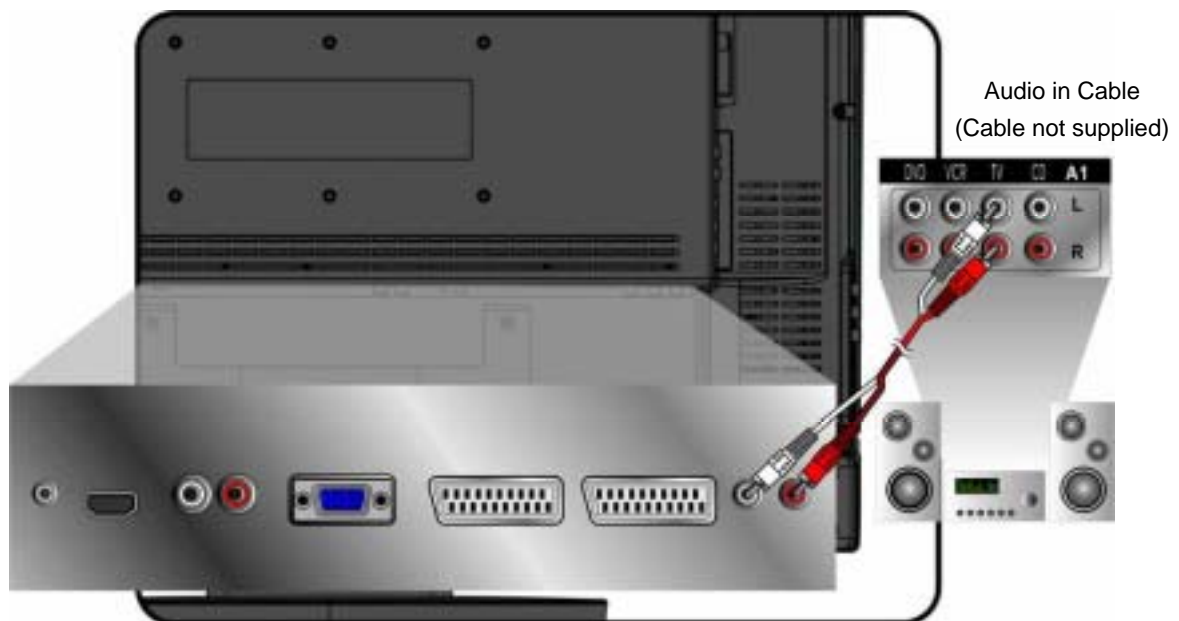

4. Connect AV, S-Video, YCbCr, YPbPr, HDMI to Video Devices

Connect Video/Audio cables from compatible devices into the right side of N2600w.

AV Mode:

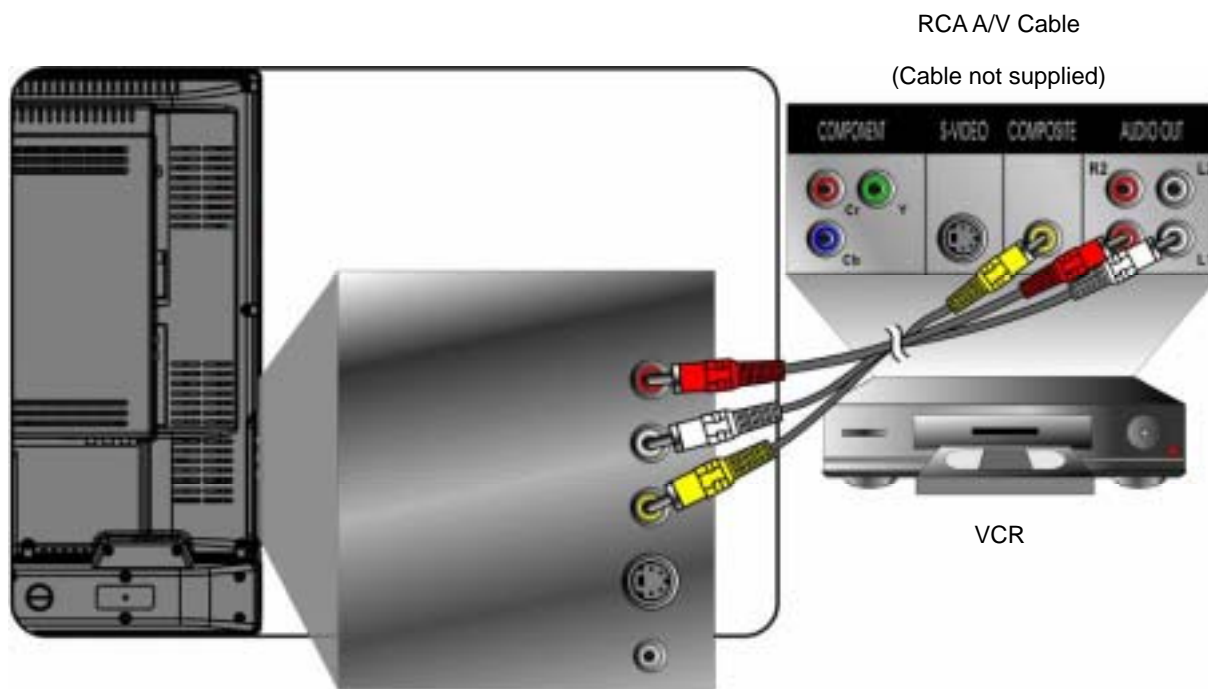

S-Video Mode:

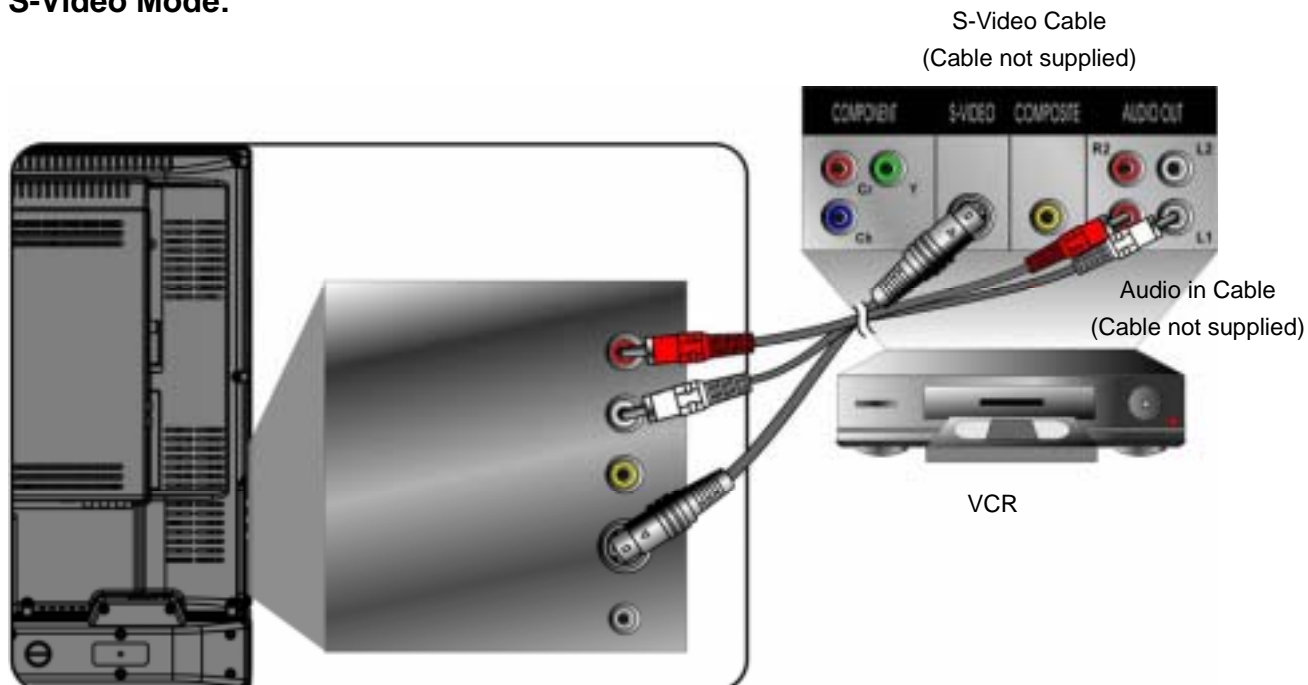

YCbCr Mode:

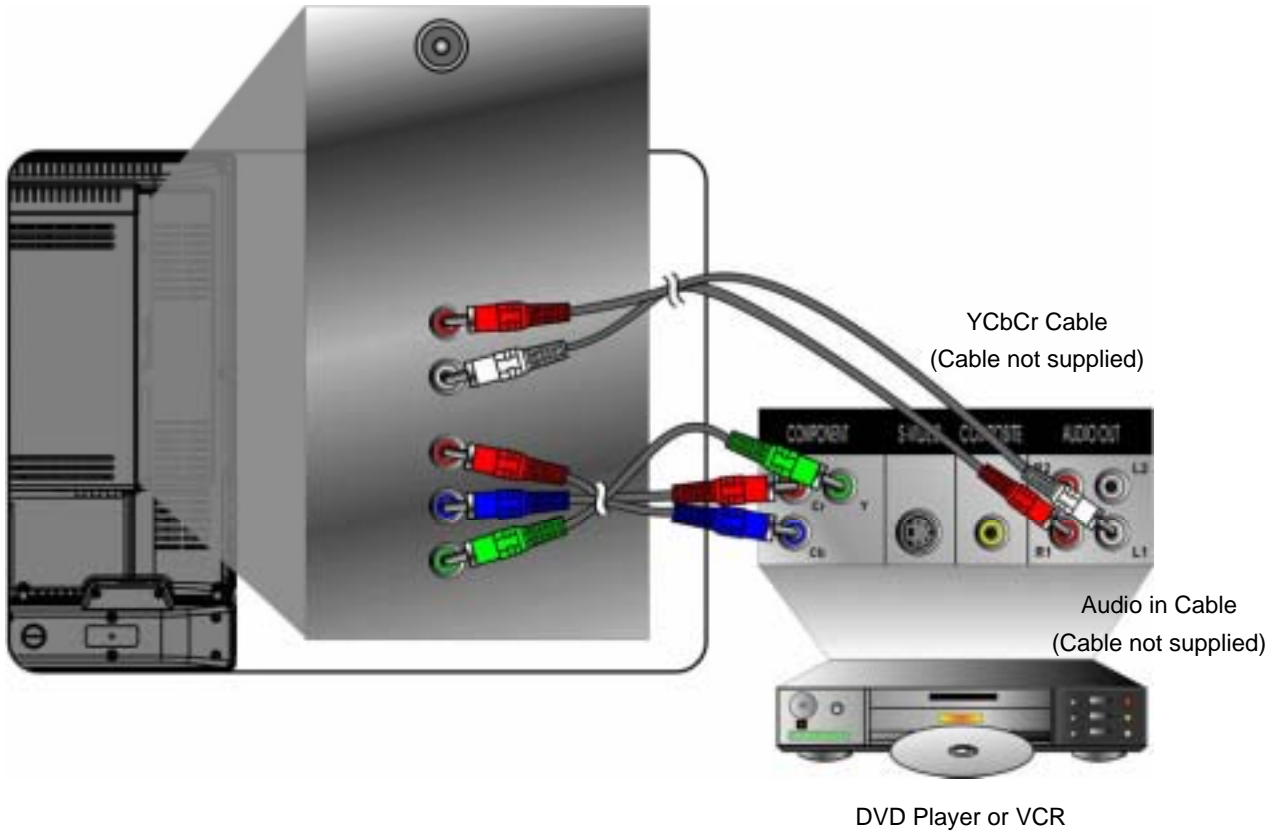

YPbPr Mode:

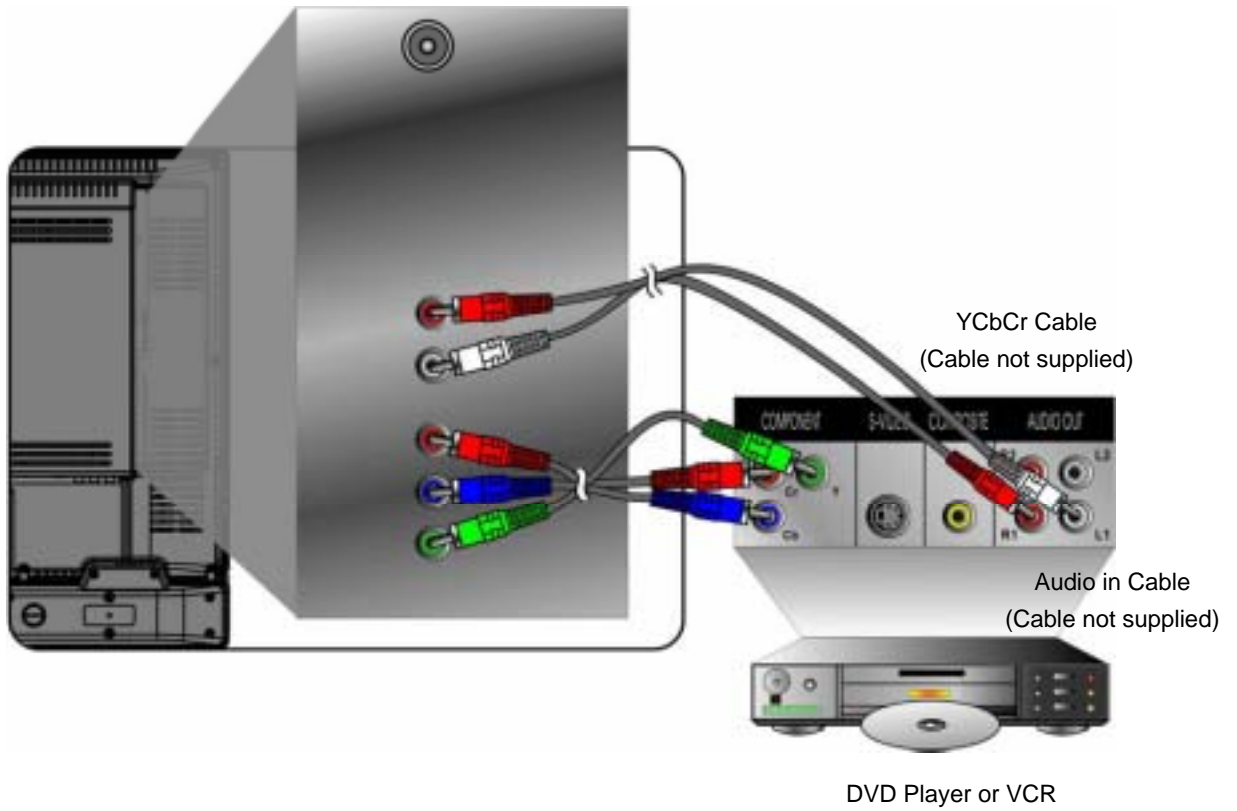

Connect with a SCART cable

SCART1 Mode:

Connect the scart socket of the VCR to the SCART1 socket on the LCD TV.

Note: The signal type RGB can only be selected for the SCART1 socket and the SCART1 input source can be received. These signals are transmitted, for example, by a pay TV decoder, game machine or photo CD unit, etc and that digital signal can be recorded via SCART1 socket.

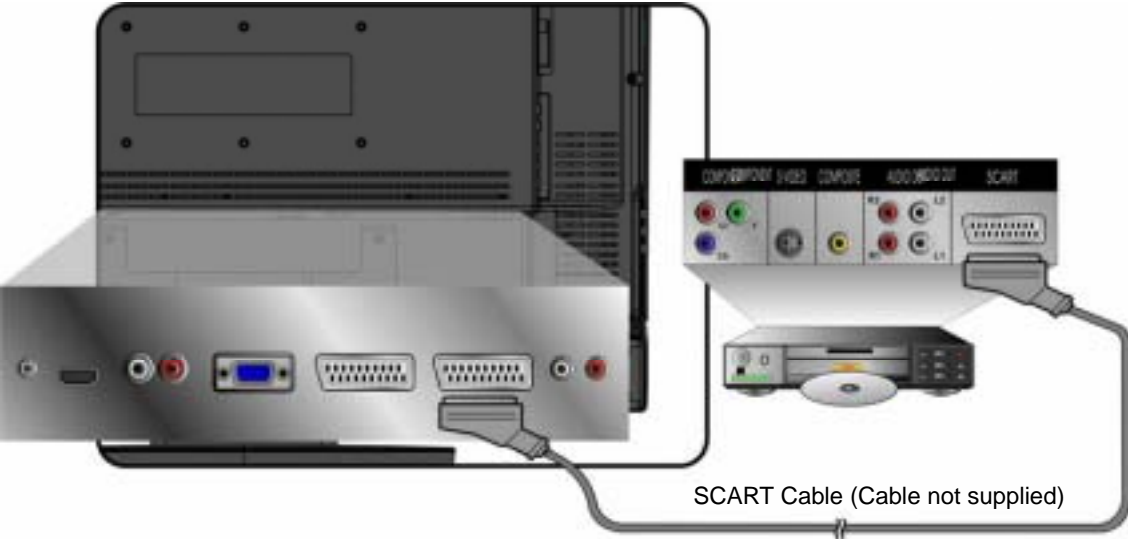

SCART2 Mode:

Connect the scart socket of the VCR to the SCART2 socket on the LCD TV.

Note: In SCART2 socket, the video output is not available.

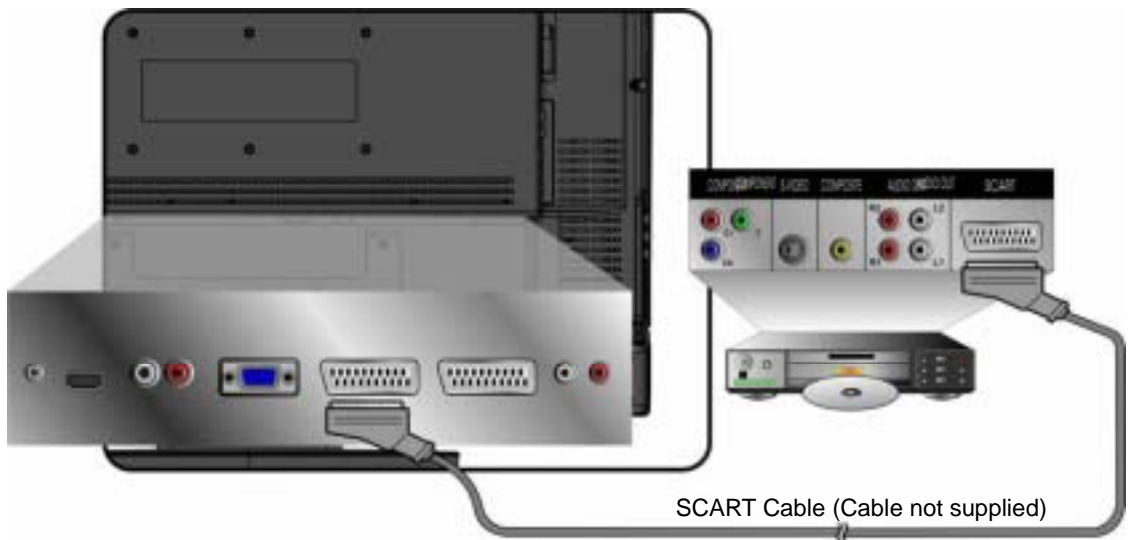

HDMI Mode:

There are two possible HDMI cable terminals of your DVD player. Please refer to one of the connection that fits for your requirement.

(1) HDMI-DVI cable

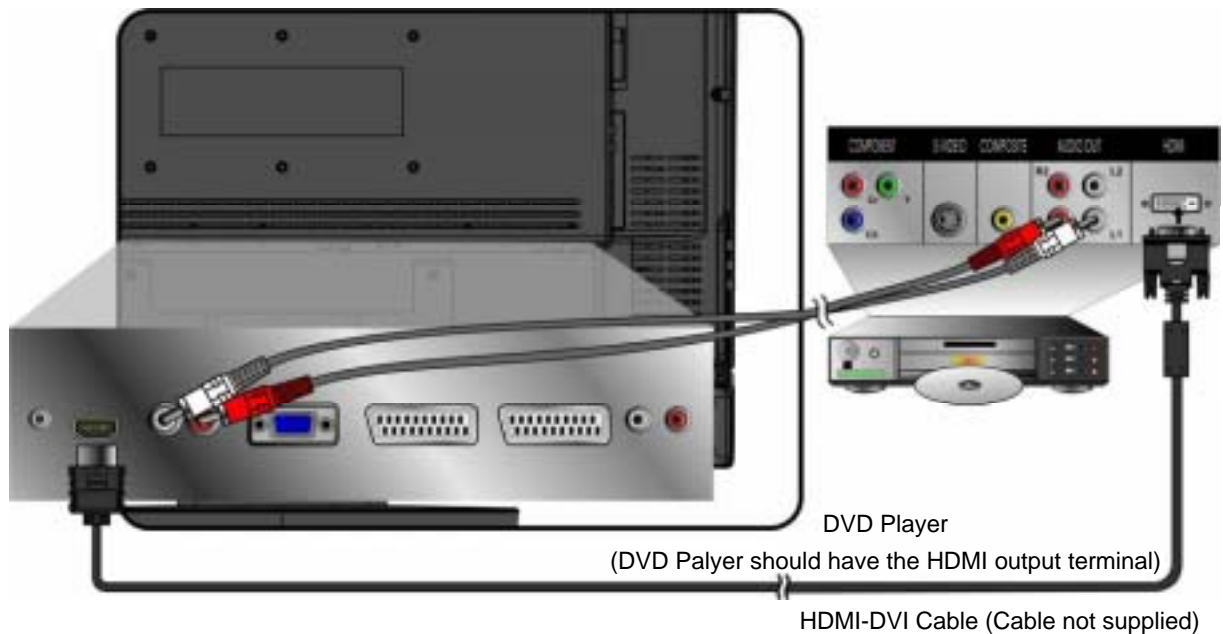

Note: To receive the sound from DVD, please turn on Sound Menu of OSD for selecting HDMI audio to YCbCr. However, the input source should be in HDMI.

(2) HDMI cable

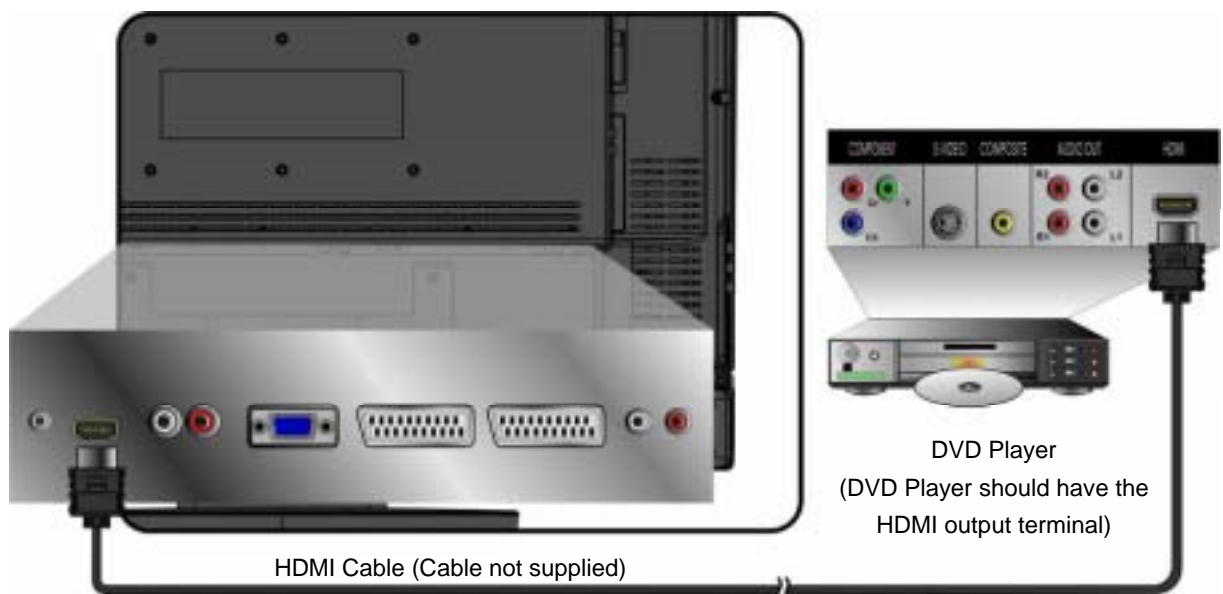

Note: To receive the sound from DVD, please turn on Sound Menu of OSD for selecting HDMI audio to HDMI. However, the input source should be in HDMI.

5. Connect to the PC

VGA (15pin D-Sub):

Connect the VGA cable from VGA output of PC to the VGA terminal input of N2600w. PC up to 1280 x 1024, or 1360 x 768 is the preferred resolution.

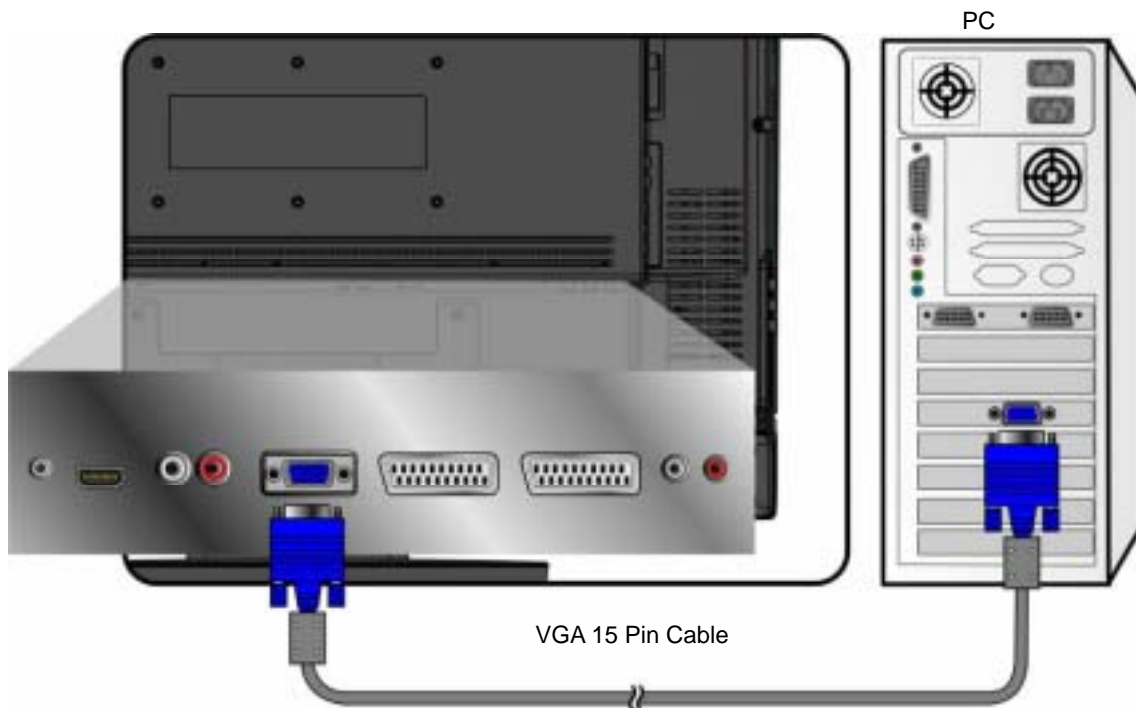

PC Audio in:

Connect the Audio In cable (green) from audio output of your PC to the audio input terminal (green) of N2600w.

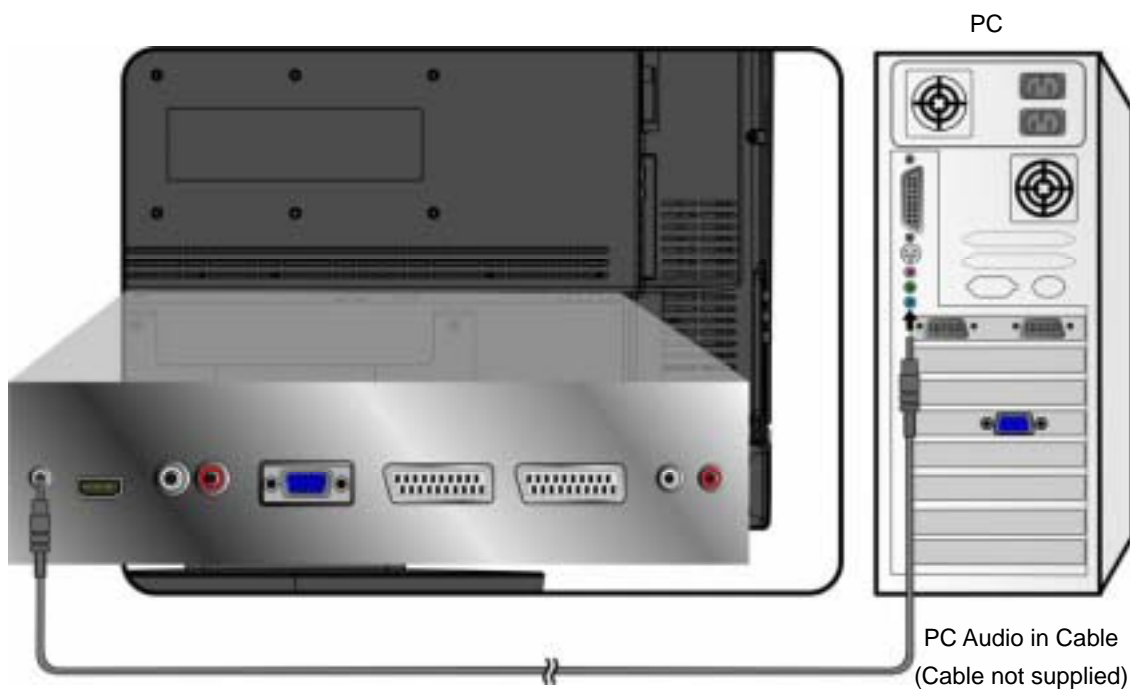

HDMI:

Connect the HDMI cable from HDMI output of PC to the DVI terminal input of N2600w.

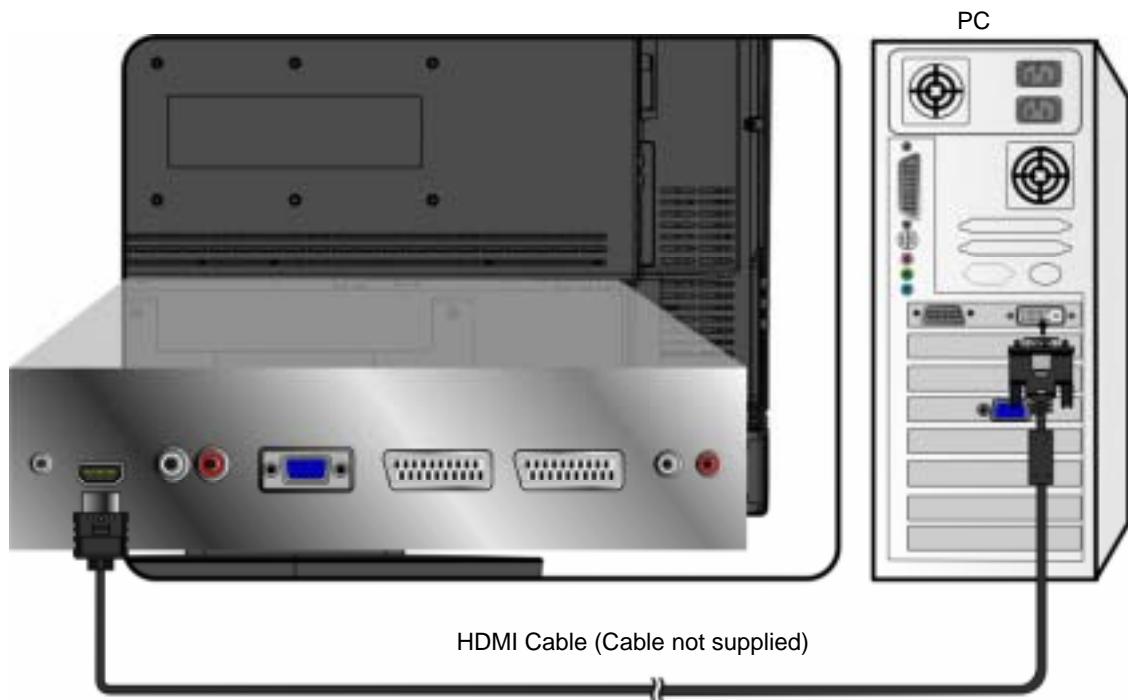
**Earphone:**

Connect Earphone from compatible devices into the earphone input at the left side of N2600w.

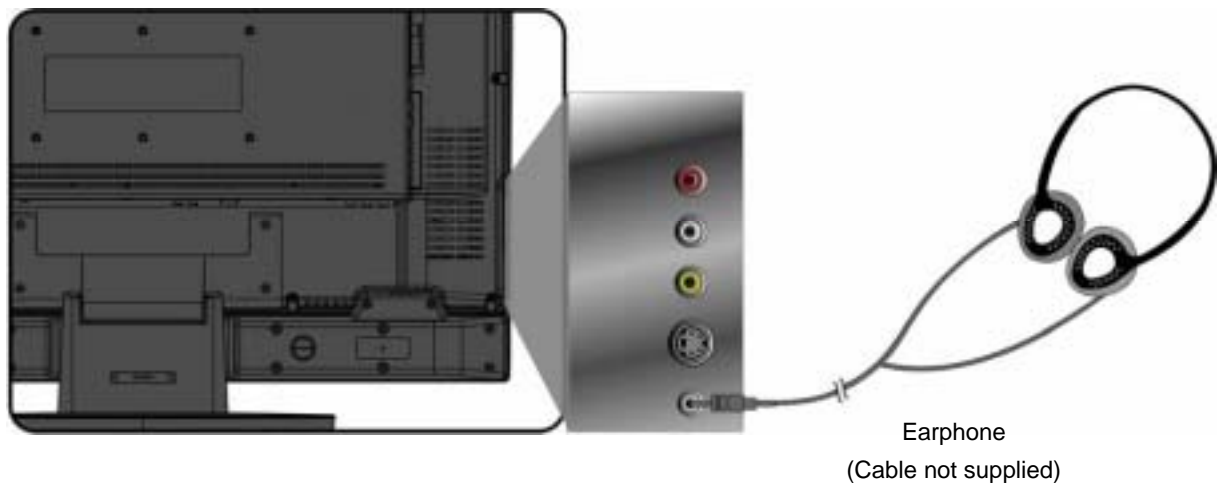

6. Connect power cable

Connect the power cord to the N2600w then to a properly grounded AC outlet. Turn on the AC Switch on the back of N2600w

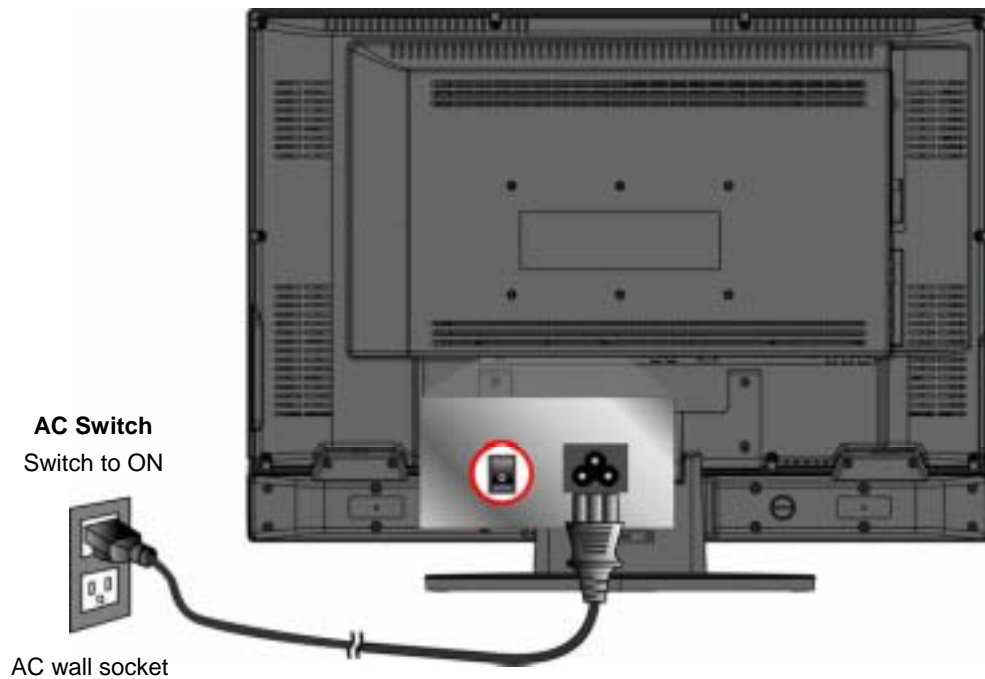

7. Turn Power ON

Press the Power button under the LCD TV, or press the Power On (red) button on the Remote Control. Turn Video source power ON.

8. Select input source for your LCD TV, via either OSD menu or Remote control

Basic Operation

To operate the function of your LCD TV, you can use your remote control or those buttons above your LCD TV to set input source, change channels, or adjust volume.

Turning on the LCD TV

Before using the LCD TV:

1. Insert the power plug.
2. Connect external equipment properly.
3. Turn on the Main AC Power Switch, located on the rear of the cabinet. (If the LCD TV will not be used for a long period of time, please turn it off) The power LED indicator will be red when AC Power Switch is on.

Power On/Off

To turn the LCD TV on/off :

Press the POWER button under the LCD TV or press the Power button on your remote control to turn on/off the TV. The power LED indicator is green when the LCD TV is on.

Select input source

Select the required input sources. Press the “Input” button at the right side of the LCD TV or on the remote control repeatedly until the desired source appears.

VOLUME Adjusting

Press **VOL-/+** at the right side of the LCD TV to adjust the volume, or press Vol▲ and Vol▼ on the remote control to adjust the volume.

To silence the volume, press **MUTE** on the remote control.

If you want to restore volume, press **MUTE** again, or press Vol▲ and Vol▼ on the remote control directly.

Channel Select

To select the channel you want, press **CH-/+** buttons at the right side of the LCD TV, or press number keys, **CH▲** or **CH▼** on the remote control to select your desired channel.

Use the button “- / —” to select the channel number with dash.

Return to the previous channel, press **RECALL** on your remote control.

OSD Functions

OSD style and operation tips

OSD Operation

Press the “Menu” button on your remote control or right side of the LCD TV to open the OSD Main Menu.

Press ▲ or ▼ button to select the sub menu, and press ◀ or ▶ to enter the sub menu.

Press ▲ or ▼ to select the function you would like to adjust, and then press ◀ or ▶ or OK to adjust it or execute the function.

Press the “Menu” button on your remote control or right side of the LCD TV again to close the OSD Main Menu.

The 5 icons at the left of the OSD Main menu stand for the 6 sub menus (Picture, Sound, TV, Option, PC, and OSD).

Picture menu

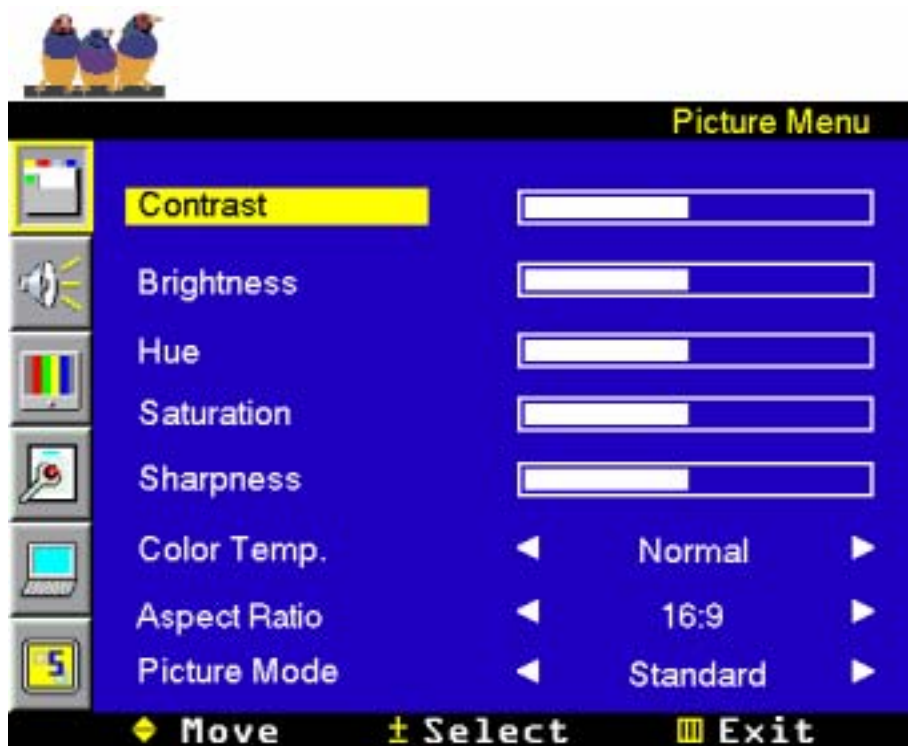

Item	Description	Operation
Contrast	Adjust the contrast level.	▶ to increase the contrast. ◀ to decrease the contrast.
Brightness	Adjust the brightness level.	▶ to brighten the display. ◀ to darken the display.
Hue	Adjust the tint level.	▶ to increase the greenish tone. ◀ to increase the reddish color.
Saturation	Adjust color saturation.	▶ to increase the brilliant color. ◀ to increase the pale color.
Sharpness	Adjust the picture sharpness.	▶ to sharpen the display. ◀ to soften the display.
Color Temp.	Set the color temperature to Normal , Warm , or Cool .	▶ or ◀: activate your selection.
Aspect Ratio	Set the view mode (16:9, Zoom, 14:9, 4:3, Panorama)	▶ or ◀: activate your selection.
Picture Mode	Set the picture mode to Standard , Movie , Vivid , or User	▶ or ◀: activate your selection.

Sound menu

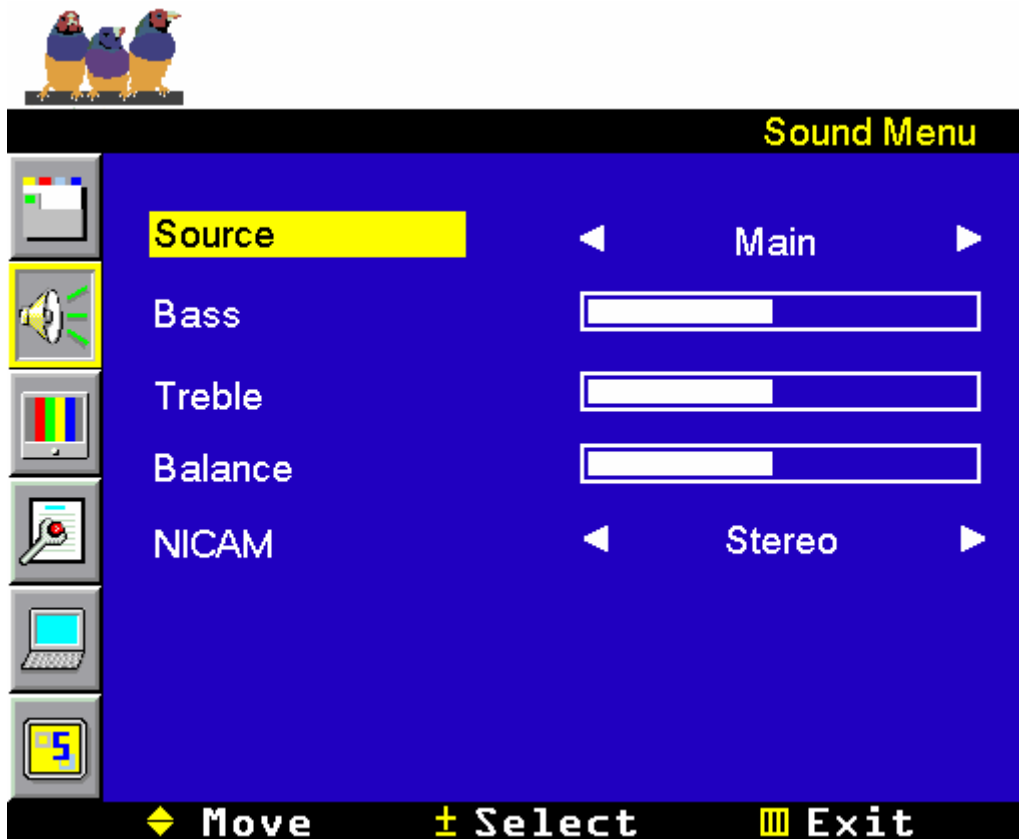

Item	Description	Operation
Source	Audio setup (Main picture or sub picture)	◀▶ to select Main or sub.
Bass	Adjust the bass.	▶ to increase lower-pitched sound. ◀ to decrease lower-pitched sound.
Treble	Adjust the treble.	▶ to increase higher-pitched sound. ◀ to decrease higher-pitched sound.
Balance	Adjust the left and right audio balance.	▶ to emphasize the right speaker. ◀ to emphasize the left speaker.
NICAM	This item is available only when the current TV broadcast supports stereo or SAP audio output format. You can switch among Mono, Stereo or SAP.	◀▶ : select Mono, Stereo or SAP.

TV menu

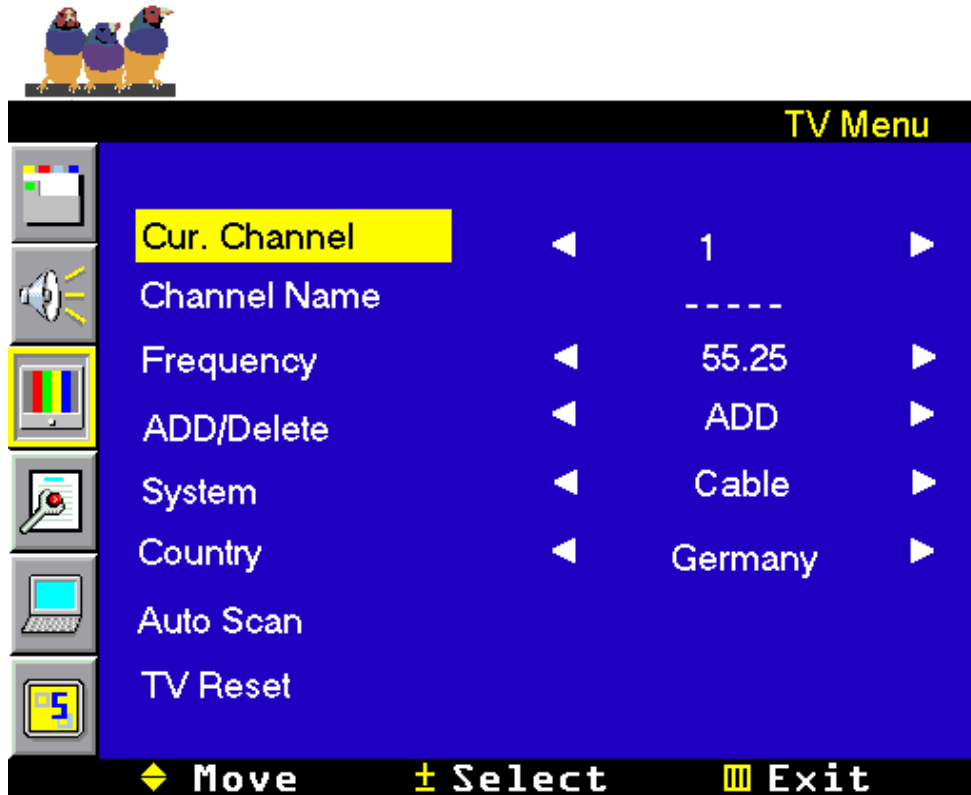

Item	Description	Operation
Cur. Channel	TV Channel Number	▶ or ◀: select current Channel Number. Default Current Channel Number
Channel Name	Current TV Channel Name	OK: modify Name MENU: leave Modify Mode ▲ or ▼:change the char value ▶ or ◀:select char
Frequency	Current TV Channel Frequency	▶ or ◀:change the value
ADD/Delete	ADD: Restores the TV channel previous deleted. Delete: Deletes the current TV channel.	▶ or ◀: select ADD or Delete .
System	Select the TV input source: Antenna or Cable .	▶ or ◀: select Cable or Antenna .
Country	Set TV Channel Country	▶ or ◀: select used country
Auto Scan/Full Search	Scan all the TV channels.	▶ or ◀: execute Auto Scan. When country is set as "other" this item shows Fully Search.
TV Reset	Reset Default Value	

Option menu

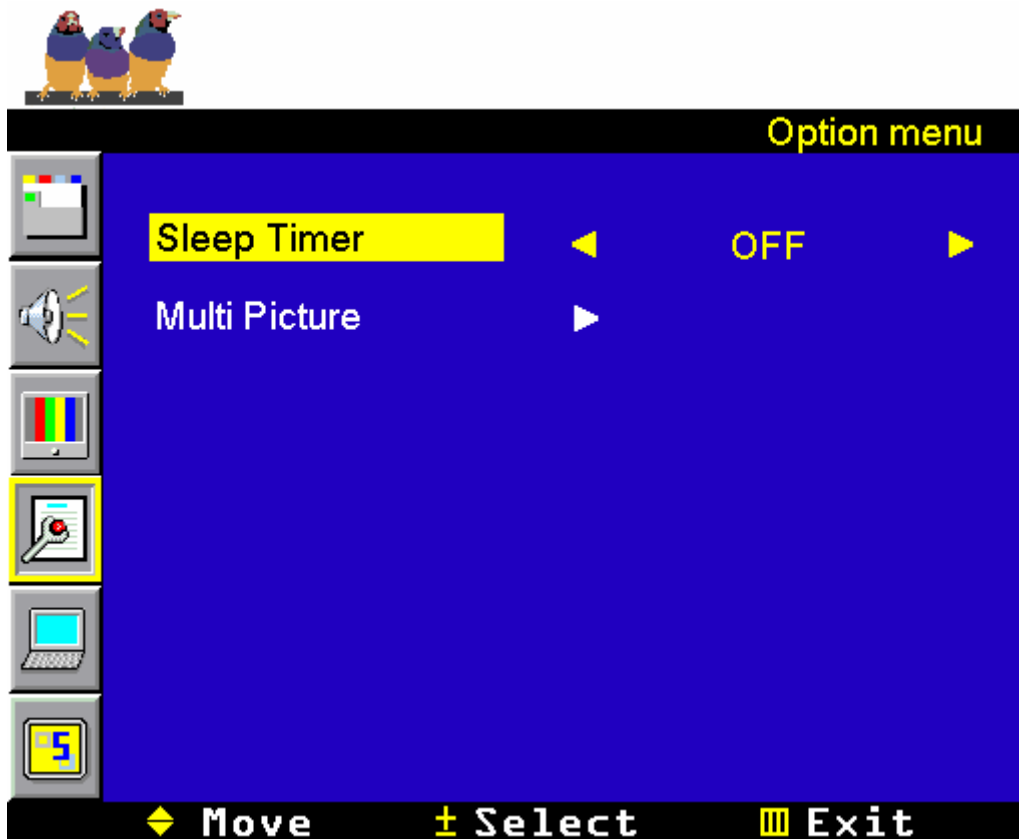

Item	Description	Operation
Sleep Timer	Set the timer for the TV to automatically turn off, Available options are OFF, 15 Min, 30 Min, 45 Min, and 60 Min.	▶ or ◀ to select OFF, 15 Min, 30 Min, 45 Min, and 60 Min.
Multi Picture	Adjust sub picture functions	▶ or ◀ enter Multi Picture sub menu.

Multi Picture Sub Menu

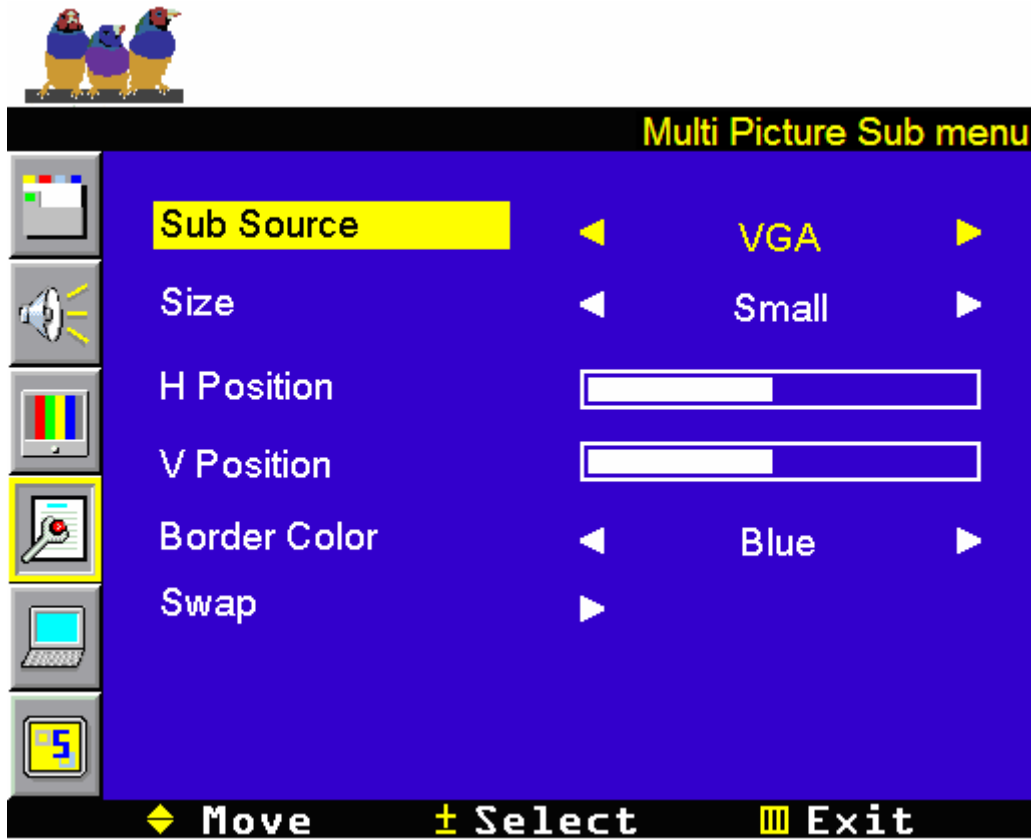

Item	Description	Operation
Sub Source	Setting Sub picture input source.	▶ or ◀ to select input source
H-Position	This item is available only if PIP is Selected. Adjust the horizontal position of the sub picture.	▶ to move toward the right. ◀ to move toward the left.
V-Position	This item is available only if PIP is Selected. Adjust the vertical position of the sub picture.	▶ to move downward. ◀ to move upward.
Border color	Sub picture Border color setup	▶ or ◀ to select color.
Swap	Change Main source and PIP source.	▶ or ◀ to change

PC Menu

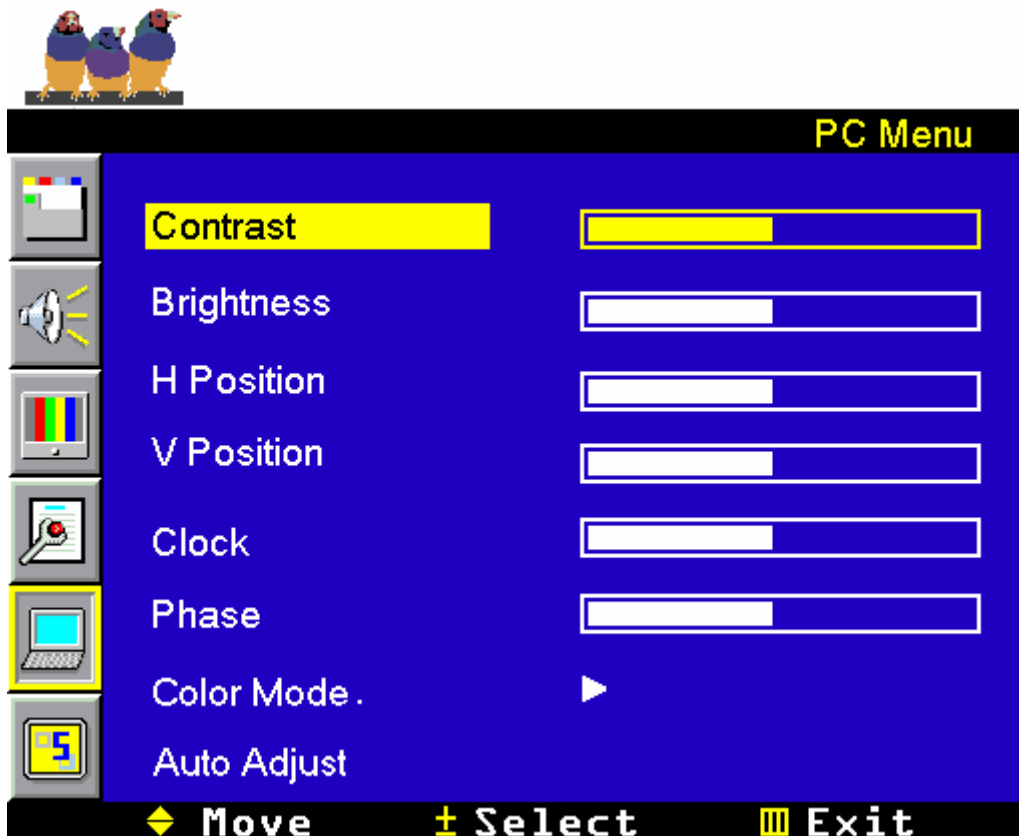

Item	Description	Operation
Contrast	Adjust the contrast level.	▶ to increase the contrast. ◀ to decrease the contrast.
Brightness	Adjust the brightness level.	▶ to brighten the display. ◀ to darken the display.
H-Position (VGA only)	Adjust the horizontal position of the video	▶ to move toward the right. ◀ to move toward the left.
V-Position (VGA only)	Adjust the vertical position of the video.	▶ to move upward. ◀ to move downward.
Clock (VGA only)	Adjust the delay time between horizontal synchronous signal and video.	▶ to increase the delay time. ◀ to decrease the delay time.
Phase (VGA only)	Adjust the delay time.	▶ to increase the delay time. ◀ to decrease the delay time.
Color Mode	Select color Mode.	▶ or ◀ enter Color Mode sub menu.
Auto Adjust (VGA only)	Automatically adjust the picture's clock, phase, horizontal position and vertical position.	▶ or ◀ to activate the function

Color Mode Sub Menu

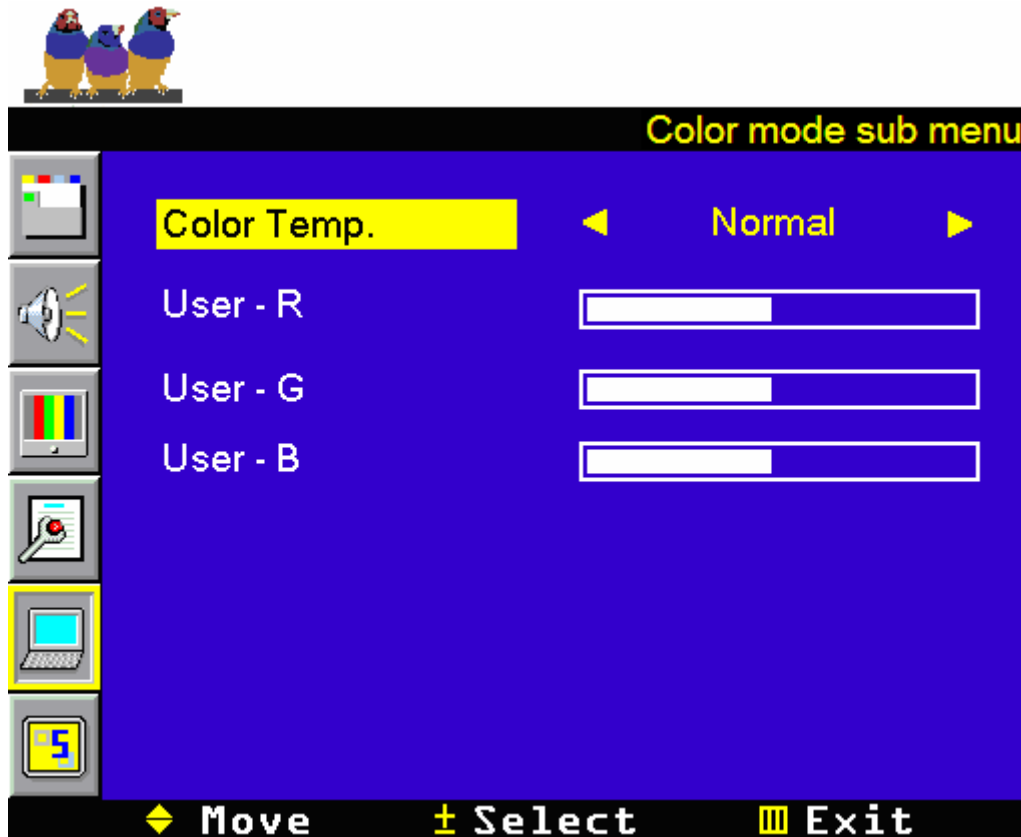

Item	Description	Operation
Color Temp.	Some default color temp set is here. Options : Normal, Warm, sRGB, User and Cool	▶ or ◀ to select color.
User-R	You can adjust R to change color temp.	▶ to increase the color temp. ◀ to decrease the color temp
User-G	You can adjust G to change color temp.	▶ to increase the color temp. ◀ to decrease the color temp
User-B	You can adjust B to change color temp.	▶ to increase the color temp. ◀ to decrease the color temp

OSD menu

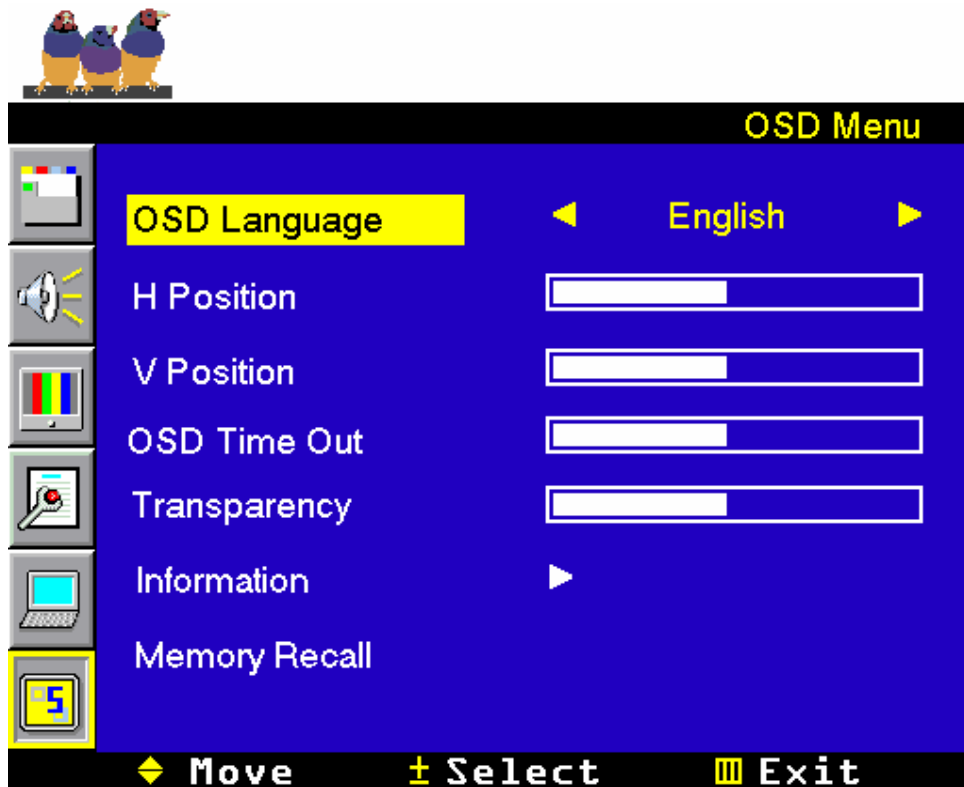

Item	Description	Operation
OSD Language	Select the OSD language.	▶ or ◀: select the OSD language.
H Position	Adjust the horizontal position of the OSD.	▶: move toward the right. ◀: move toward the left.
V Position	Adjust the vertical position of the OSD.	▶: move upward. ◀: move downward.
OSD Time Out	Adjust OSD display time. Range 0~60 sec.	▶: increase the OSD display time. ◀: decrease the OSD display time.
Transparency	Adjust OSD's transparency level.	▶: increase the transparency. ◀: decrease the transparency.
Information	Show some Picture information including main/sub picture source and firmware version.	▶ or ◀: display information.
Memory Recall	Reset the OSD settings to default. OSD Language and Input Source settings are not affected.	▶ or ◀: activate the function.

Other Information

Specifications

LCD	Type	26" view able	
	Color Filter	0.4215(H) x 0.4215(V) mm pixel pitch	
	Glass surface	RGB vertical stripe Anti-Glare	
Input signal	RGB	RGB analog (0.7/1.0 Vp-p, 75 ohms) Separate Sync, f _h :30-80 kHz, f _v :50-75 Hz	
	RF	TV system Antenna/ PAL/SECAM	
	Video	D-sub x 1, RCA Composite x 1, S-Video x 1 RCA Component x 1 set (YCbCr/YPbPr) HDMI X 1, SCART x 2	
	Audio	Mini-stereo (∅3.5mm) x 1, 3 pair of RCA (L/R) stereo jack	
Compatibility	PC	Up to 1360 x 768 Non-interlaced	
Resolution		1360 x 768 @ 60 Hz	
Speaker Output		5W x 2	
Audio Output		1 pair of RCA (L/R) stereo jack	
		Earphone Mini-stereo (∅3.5mm) x 1	
Power	Voltage	90-240 VAC, 50/60 Hz (auto switch)	
Display Area	Full Scan	575.769mm (H) x 323.712 mm (V)	
Operating Conditions	Temperature	32° F to + 104° F (0° C to + 40° C)	
	Humidity	10% to 90% (non-condensing)	
Storage Conditions	Temperature	-4° F to + 140° F (-20° C to + 60° C)	
	Humidity	10% to 90% (non-condensing)	
Dimensions	Physical	688 mm (W) x 546 mm (H) x 250 mm (D)	
		27.08 in (W) x 21.49 in (H) x 9.84 in (D)	
Weight	Net	13.6 kg (29.96 lb.)	
	Gross	17.0kg (37.44 lb.)	
Regulations		CE	
Power Saving Mode	On	< 180W	LED Green
	Active Off	< 3W	LED Off

Preset Timing Mode (pre-adjusted to GTF 1360 x 768 @ 60 Hz)

Warning: Do not set the graphics card in your computer to exceed these refresh rates; doing so may result in permanent damage to the LCD TV.

Note: Product Specifications are subject to change without notice.

Troubleshooting

No power

- Make sure the LCD TV is properly connected.
- Make sure the AC power cord is properly connected.
- Make sure the AC power is ON, DC power button is ON (Green LED).
- Plug another electrical device (like a radio) to the power outlet to verify that the outlet is supplying the proper voltage.

Poor or no picture

- The TV station may be experiencing problems. Try another channel.
- The Cable TV signal may be scrambled or encoded. Please contact your local cable operator.
- Make sure that connection to other components are correct.
- Make sure that setup has been done correctly after connections.
- Make sure the correct input is selected and the input signal is compatible.

Strange color, light color, or color misalignment

- Ensure that the video cable is securely connected.
- The picture may appear dim in a brightly lit room.
- Adjust brightness and contrast.
- Check the input signal setting.

No Sound

- Check your audio connections
- The MUTE button may have been pressed, try pressing this button again.
- Check your audio settings, your TV audio may be set to minimum.
- Press the Volume + (Up) button on the remote control.

Remote control unit does not operate

- Make sure batteries are inserted correctly.
- Batteries could be weak or dead. Replace batteries.
- Is a fluorescent light illuminated near the remote control sensor?
- The path of the remote control beam may be blocked. Make sure the path is clear and that the remote control is aimed at the remote control sensor on the TV.
- Press only one button at a time and it is the correct one for the operation you want to perform.

Unit cannot be operated

- External influences such as lightning or static electricity may cause improper operation. In this case, operate the unit after first turning on the power of the LCD TV and the AVC System, or unplug the AC cord for 1 to 2 minutes, then replug again.

Power is cut off suddenly

- Is the sleep timer set?
- The internal temperature of the unit has increased. Remove any objects blocking the vent or clean as necessary.

No CATV reception (or no reception above CH13)

- Is the AIR/CABLE option set correctly? Please set the AIR/CABLE option to CABLE.
- CATV is connected improperly or not connected; please check all the CATV connections.
- The cable TV service is interrupted; please contact your cable operator.

Picture is cut off/with sidebar screen

- Is the image positioned correctly?
- Are screen mode adjustments such as picture size set correctly?

Customer Support

For technical support or product service, see the table below or contact your reseller.

NOTE: You will need the product serial number.

Contry / Region	Web site	Telephone
Austria	www.viewsoniceurope.com/aus	0150 159 6005
Belgium	www.viewsoniceurope.com/befl www.viewsoniceurope.com/befr	02 256 6642
Denmark	www.viewsoniceurope.com/dk	35 25 65 12
Finland	www.viewsoniceurope.com/fi	09 2311 3413
France	www.viewsoniceurope.com/fr	03 8717 1616
Germany	www.viewsoniceurope.com/de	0696 630 8051
Republic of Ireland	www.viewsoniceurope.com/uk	01 411 8936
Italy	www.viewsoniceurope.com/it	02 4527 9033
Luxembourg	www.viewsoniceurope.com/lu	40 6661 5618
The Netherlands	www.viewsoniceurope.com/nl	053 484 9308
Norway	www.viewsoniceurope.com/no	22 57 77 38
Portugal	www.viewsoniceurope.com/uk	21359 1423
Russia	www.viewsoniceurope.com/ru	800-200-8439
Spain	www.viewsoniceurope.com/es	913 496 534
Sweden	www.viewsoniceurope.com/se	08 5792 9045
United Kingdom	www.viewsoniceurope.com/uk	0207 949 0307

Limited Warranty

VIEWSONIC® LCD TV

What the warranty covers:

ViewSonic warrants its products to be free from defects in material and workmanship, under normal use, during the warranty period. If a product proves to be defective in material or workmanship during the warranty period, **ViewSonic** will at its sole option, repair or replace the product with a like product. Replacement product or parts may include remanufactured or refurbished parts or components.

How long the warranty is effective:

ViewSonic LCD TV's are warranted for one (1) year for all parts excluding the light source and one (1) year for labor from the date of the first consumer purchase.

Who the warranty protects:

This warranty is valid only for the first consumer purchaser.

What the warranty does not cover:

1. Any product on which the serial number has been defaced, modified or removed.
2. Damage, deterioration or malfunction resulting from:
 - a. Accident, misuse, neglect, fire, water, lightning, or other acts of nature, unauthorized product modification, or failure to follow instructions supplied with the product.
 - b. Repair or attempted repair by anyone not authorized by **ViewSonic**.
 - c. Any damage of the product due to shipment.
 - d. Removal or installation of the product.
 - e. Causes external to the product, such as electrical power fluctuations or failure.
 - f. Use of supplies or parts not meeting **ViewSonic's** specifications.
 - g. Normal wear and tear.
 - h. Any other cause which does not relate to a product defect.
3. Any product exhibiting a condition commonly known as "image burn-in" which results when a static image is displayed on the product for an extended period of time.
4. Removal, installation, and set-up service charges.

How to get service:

1. For information about receiving service under warranty, contact **ViewSonic Customer Support at 800-888-8583**. You will need to provide your product's serial number.
2. To obtain warranted service, you will be required to provide (a) the original dated sales slip, (b) your name, (c) your address, (d) a description of the problem, and (e) the serial number of the product.
3. Take or ship the product freight prepaid in the original container to an authorized **ViewSonic** service center or **ViewSonic**.
4. For additional information or the name of the nearest **ViewSonic** service center, contact **ViewSonic**.

Limitation of implied warranties:

There are no warranties, express or implied, which extend beyond the description contained herein including the implied warranty of merchantability and fitness for a particular purpose.

Exclusion of damages:

ViewSonic's liability is limited to the cost of repair or replacement of the product. **ViewSonic** shall not be liable for:

1. Damage to other property caused by any defects in the product, damages based upon inconvenience, loss of use of the product, loss of time, loss of profits, loss of business opportunity, loss of goodwill, interference with business relationships, or other commercial loss, even if advised of the possibility of such damages.
2. Any other damages, whether incidental, consequential or otherwise.
3. Any claim against the customer by any other party.

Effect of state law:

This warranty gives you specific legal rights, and you may also have other rights which vary from state to state. Some states do not allow limitations on implied warranties and/or do not allow the exclusion of incidental or consequential damages, so the above limitations and exclusions may not apply to you.

Sales outside the U.S.A. and Canada:

For warranty information and service on **ViewSonic** products sold outside of the U.S.A. and Canada, contact **ViewSonic** or your local **ViewSonic** dealer.

